

Drenaggio interno HT

Il programma completo. Facile montaggio ad incastro che consente per questo una posa rapida e pulita!

- tubi e pezzi stampati per condutture della fognatura all'interno di edifici secondo DIN EN 1451-1
- resistente all'acqua bollente fino a 90°C
- adatto ad acque di scarico bollenti, fredde e aggressive
- semplice collegamento con muffola ad innesto
- posa rapida e razionale con pendenza minima
- diametro nominale DN 40/50/75/110
- materiale: polipropilene difficilmente infiammabile = PP secondo DIN 4102/B1
- colore: grigio polvere RAL 7037

Bagno

Montaggio della tubazione della fognatura al di sotto del pavimento. Cassetta di scarico non incorporata.

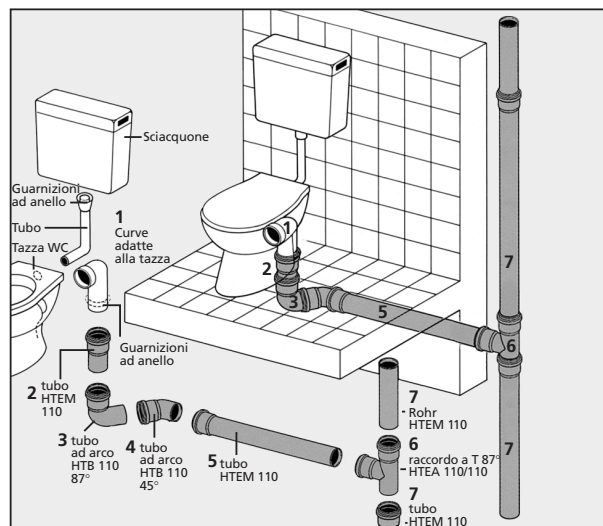

Lavandino

Posa della tubazione della fognatura nella parete. Collegamento sotto il pavimento.

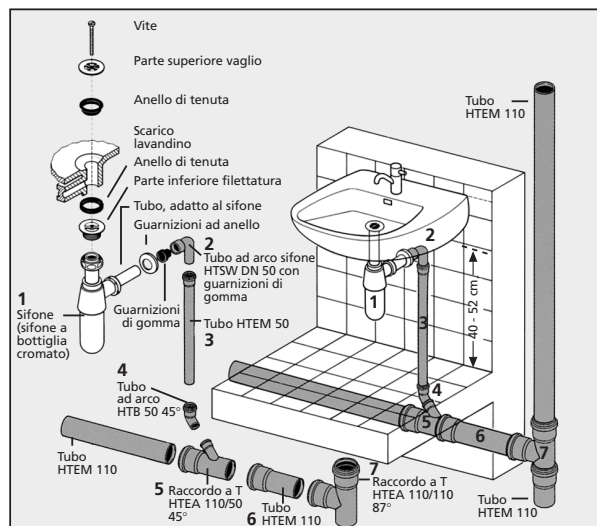

Doccia

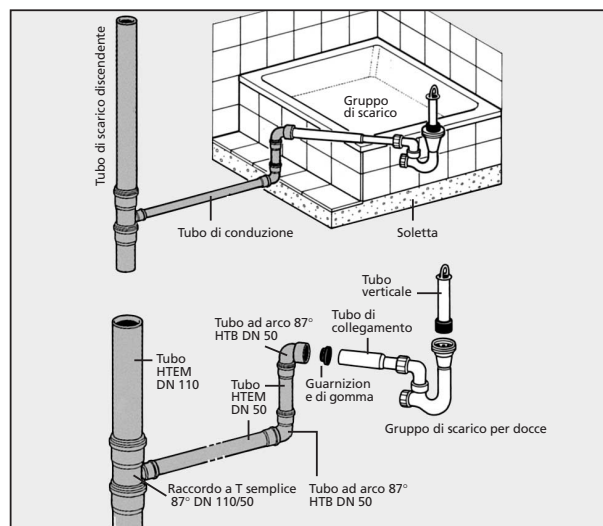

Lavandino e lavastoviglie

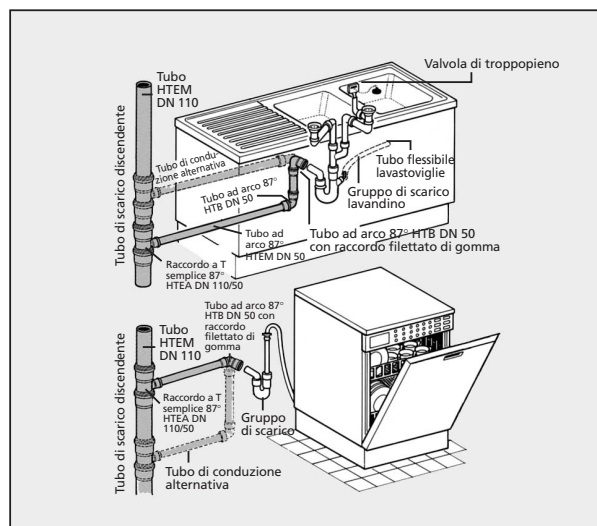









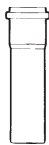













Ulteriori informazioni
www.marley.de











Fallo con Marley.

Drenaggio interno Marley HT

Il programma HT per un semplice montaggio ad incastro.
Con guarnizione a labbro pre-montata

Articolo	DN	EAN-Nr. 4002644...	Quantità
Tubo HTEM con muffola ad innesto 	150 mm	40	090023
		50	090030
		75	090047
		110	090054
	250 mm	40	090122
		50	090139
		75	090146
		110	090153
	500 mm	40	090221
		50	090238
		75	090245
		110	090252
	750 mm	40	090320
		50	090337
		75	090344
		110	090351
	1000 mm	40	090429
	50	090436	
	75	090443	
	110	090450	
1500 mm	40	090627	
	50	090634	
	75	090641	
	110	090658	
2000 mm	40	090825	
	50	090832	
	75	090849	
	110	090856	
Tubo ad arco HTB 15° 	40	091129	
	50	091136	
	75	091143	
	110	091150	
Tubo ad arco HTB 30° 	40	091228	
	50	091235	
	75	091242	
	110	091259	
Tubo ad arco HTB 45° 	40	091327	
	50	091334	
	75	091341	
	110	091358	
Tubo ad arco HTB 67° 	40	091426	
	50	091433	
	75	091440	
	110	091457	
Tubo ad arco HTB 87° 	40	091624	
	50	091631	
	75	091648	
	110	091655	
Raccordo a T semplice HTEA 45° 	40/40	091716	
	50/40	091723	
	50/50	091730	
	75/50	091754	
	75/75	091761	
	110/50	091778	
	110/75	091785	
	110/110	091792	
Raccordo a T semplice HTEA 67° 	40/40	091815	
	50/40	091822	
	50/50	091839	
	75/50	091853	
	75/75	091860	
	110/50	091877	
	110/75	091884	
	110/110	091891	
Raccordo a T semplice HTEA 87° 	40/40	091914	
	50/40	091921	
	50/50	091938	
	75/50	091952	
	75/75	091969	
	110/50	091976	
	110/75	091983	
110/110	091990		

Articolo	DN	EAN-Nr. 4002644...	Quantità
Raccordo a T doppio HTDA 67° 	50/50/50	092126	
	75/75/75	092133	
	110/50/50	092140	
	110/75/75	092157	
	110/110/110	092164	
Raccordo angolare HTDA 67° 	110/110/110	092171	
Tubo di giunzione HTR eccentrico 	50/40	092324	
	75/50	092348	
	110/50	092355	
	110/75	092362	
Manicotto lungo HTL (scomparto 2 1/2) 	40	092423	
	50	092430	
	75	092447	
	110	092454	
Bicchiere HTU 	40	092522	
	50	092539	
	75	092546	
	110	092553	
Tubo di depurazione HTRE 	50	092737	
	75	092744	
	110	092751	
Tamponi manicotti HTM 	40	092829	
	50	092836	
	75	092843	
	110	092850	
Angolo sifone 90° HTSW 	40/30	092928	
	40/40	092935	
	50/40	092942	
	50/50	092959	
Doppio sifone 90° HTDSB 	40/50/40	092966	
Raccordo sul tubo di metallo HTS 	40/40	093024	
	50/40	093031	
Raccordo sul tubo di ghisa HTUG 	50/50	093048	
	50	093352	
	75	093369	
Morsetto HT zincato 	110	093376	
	40	093628	
	50	093635	
Morsetto HT con vite filettata senza testa 8 x 80 mm 	75	093642	
	110	093659	
	40	093666	
	50	093673	
	75	093680	
	110	093697	

Articolo	DN	EAN-Nr. 4002644...	Quantità
Lubrificante 150 ml		093963	
Tubo HTGL senza manicotto 	5 m	40	090863
	5 m	50	090870
	5 m	75	090887
	5 m	110	090894
Morsetto HT ad isolamento acustico 	40	093727	
	50	093734	
	75	093741	
Morsetto HT ad isolamento acustico con vite filettata 8 x 80 mm 	110	093758	
	40	093765	
	50	093772	
	75	093789	
HTGM, guarnizioni di gomma per sifoni 90° e HTS	für NW 40/30	40/30 A	094649
	40/40	40/30 B	094656
	50/40	40/40 C	094663
	50/50	50/30 D	094670
		50/40 E	094687
		50/50 F	094694
Raccordo filettato di gomma con bulbo a nervatura per tubi di metallo o piombo 	40-1 1/4"	094700	
	50-1 1/4"	094717	
	50-1 1/2"	094724	
Doppia guarnizione per manicotti 	50	094731	
	75	094748	
Tubo di ghisa	110	094755	
Anelli di tenuta di ricambio 	40	094762	
	50	094779	
	75	094786	
	110	094793	
Tubo flessibile HT 	250 mm	50	093918
	500 mm	50	093925
	750 mm	50	093932
	1000 mm	50	093949
Aeratore tubo HT DN 32-DN50 	32/40/50	093833	
Aeratore tubo HT DN 75-DN 110 	75/90/110	093840	
Raccordo 	75-89/110-115	338101	
	110-115/121-136	338149	
	110-125/144-160	338163	
	75-89	338231	
	110-115	338262	

Fallo con Marley.